



GAI-TRONICS®
A HUBBELL COMPANY

SP2 Weatherproof Handset/Speaker Amplifier Station Quick Installation Guide

General Information

This guide covers the installation of SP2 weatherproof handset/speaker amplifier stations (see Figure 1). Refer to Publication 42004-786 for detailed explanations of the available configuration options and adjustments, system specifications, and warranty information. GAI-Tronics' product documentation is on the GAI-Tronics website at <https://www.gai-tronics.com>.

Options

The factory installs and preconfigures optional equipment to default settings.

- 24 V dc power supply
- speaker amplifier only (no handset)
- headset with page pressbar
- five configurable alternate page destinations with selector switch
- PVC or Hytel® handset cords in 6-, 15-, or 25-foot lengths
- All-Call push button
- conformal PCBA coating

Settings and Adjustments

Complete following settings and adjustments after installation:

- speaker volume
- receiver volume
- series/parallel speaker connection
- station ID and zone selector

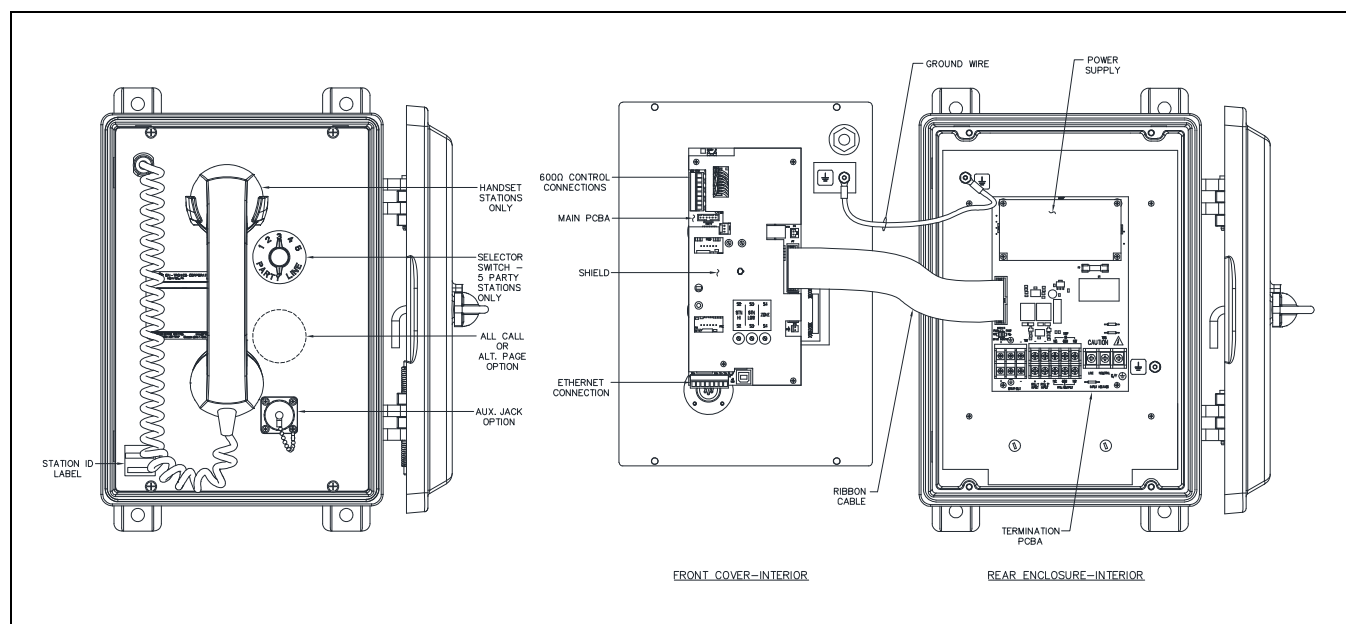

Figure 1. SP2 Weatherproof Handset/Speaker Amplifier Station



GAI-TRONICS 3030 KUTZTOWN RD. READING, PA 19605 USA

610-777-1374 ■ 800-492-1212 ■ Fax: 610-796-5954



VISIT WWW.GAI-TRONICS.COM FOR PRODUCT LITERATURE AND MANUALS



Important Safety Instructions

- **Read, follow, and retain instructions**—Read and follow all safety and operating instructions before operating the unit. Retain instructions for future reference.
- **Heed warnings**—Adhere to all warnings on the unit and in the operating instructions.
- **Attachments**—Do not use attachments not recommended by the product manufacturer, as they may cause hazards.
- **Servicing**—Do not attempt to service this unit. Opening or removing covers may expose dangerous voltage or other hazards. Refer all servicing to qualified service personnel.

 **ATTENTION**  —Install equipment without modification and according to all applicable local, national, and international electrical codes. North America—Consult the National Electrical Code (NFPA 70), Canadian Standards Association (CSA 22.1), and local codes for specific requirements regarding your installation. Install Class 2 circuit wiring in accordance with the NEC.

Only trained, qualified, and competent personnel must install these enclosures. Installation must comply with state and national regulations, as well as safety practices for this type of equipment.

 **WARNING**  —*In 24 V dc systems:* Do **NOT** operate this equipment from a battery charger with the batteries disconnected. Most 24 V dc battery chargers have an unloaded output of 35 to 45 volts that can quickly damage equipment designed for 24 volts nominal. Do not allow the maximum battery voltage to exceed the maximum specified input voltage.

 **WARNING**  —**Do not disconnect equipment while energized.**
Ensure proper grounding to protective earthing.

Installation

Enclosure Mounting

Mount the enclosure to a flat surface that provides proper clearance, rigidity, and strength to support the enclosure and all contained devices.

1. Mount the enclosure using the four 0.437-inch (11 mm) diameter holes located on the mounting flanges with 3/8-inch (M8) hardware (see [Figure 2](#)).
 - The suggested mounting height for all station enclosures is 48 inches (1219 mm) to the center of the bottom mounting holes of the enclosure.
 - SP2 stations are not supplied with conduit or cable openings.
2. Remove the front panel.
3. Drill or punch entry openings in the rear section of the enclosure (see [Figure 2](#)).
 - The station is suitable for bottom and/or side entry.
 - *Recommended:* Bottom entry prevents condensation that may form in the conduit from dripping onto the termination PCBA.
 - The minimum material (spacing) between entry holes is ½ inch (13 mm).

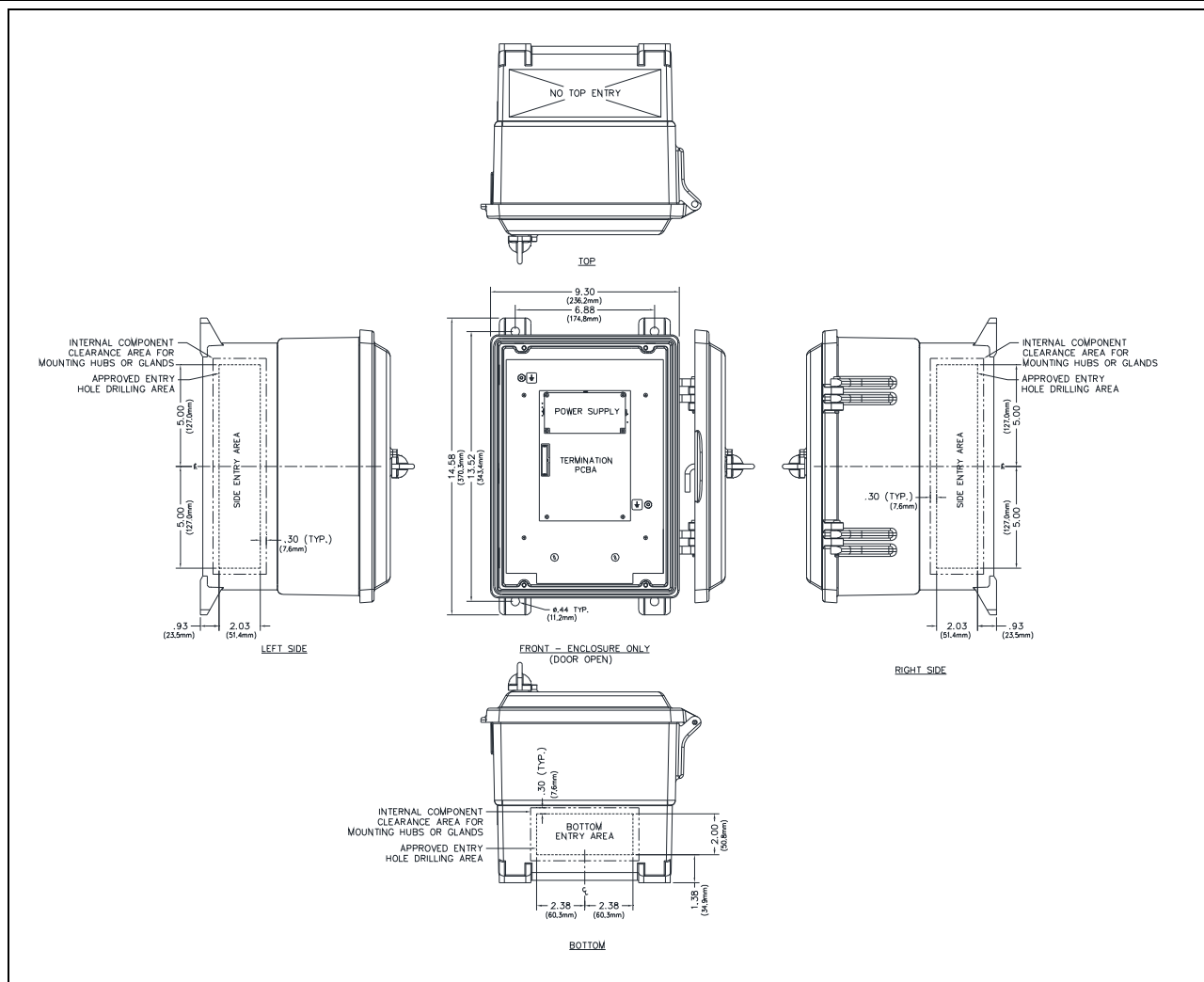

Figure 2. Suggested Wire Entry Locations

Field Wiring

The SP2 station provides terminal blocks on the termination PCBA, located in the rear enclosure, for field wiring the power, speaker, and RTU connections. The main PCBA, mounted to the back of the front panel, provides pluggable terminal blocks for the 600-ohm audio and Ethernet network connections (see Figure 3).

NOTE: Use shielded Ethernet cable or metallic conduit for installation.

1. Install spade lugs or ferrules on the wires before connection to the terminal blocks.
2. Torque the terminal block screws to 8–10 in·lb (0.90–1.13 N·m) when connecting the spade lugged wires.
3. Connect the station enclosure to earth ground.
 1. Install a #6 ring lug on the ground conductor.
 2. Secure it to the ground terminal located in the lower right corner at the back of the rear enclosure (see Figure 3).
4. Terminate the direct speaker connection to terminal block TB1 on the termination PCBA.

A redundant set of terminals is provided for a second speaker branch that can be connected in series or parallel with the primary speaker.
5. Configure the speaker jumpers; P2 and P3, for the impedance of the connected speakers (see Figure 3).
6. Terminate the RTU inputs and output to terminal block TB2 on the termination PCBA.
7. Terminate the power input to terminal block TB3 on the termination PCBA.
8. Terminate the 600-ohm audio connections to terminal block TB1 on the main PCBA.
9. Terminate the Ethernet connection to terminal block TB2 on the main PCBA.

Maximum Ethernet cable length is 100 m. Minimum cable specification is category 5e.

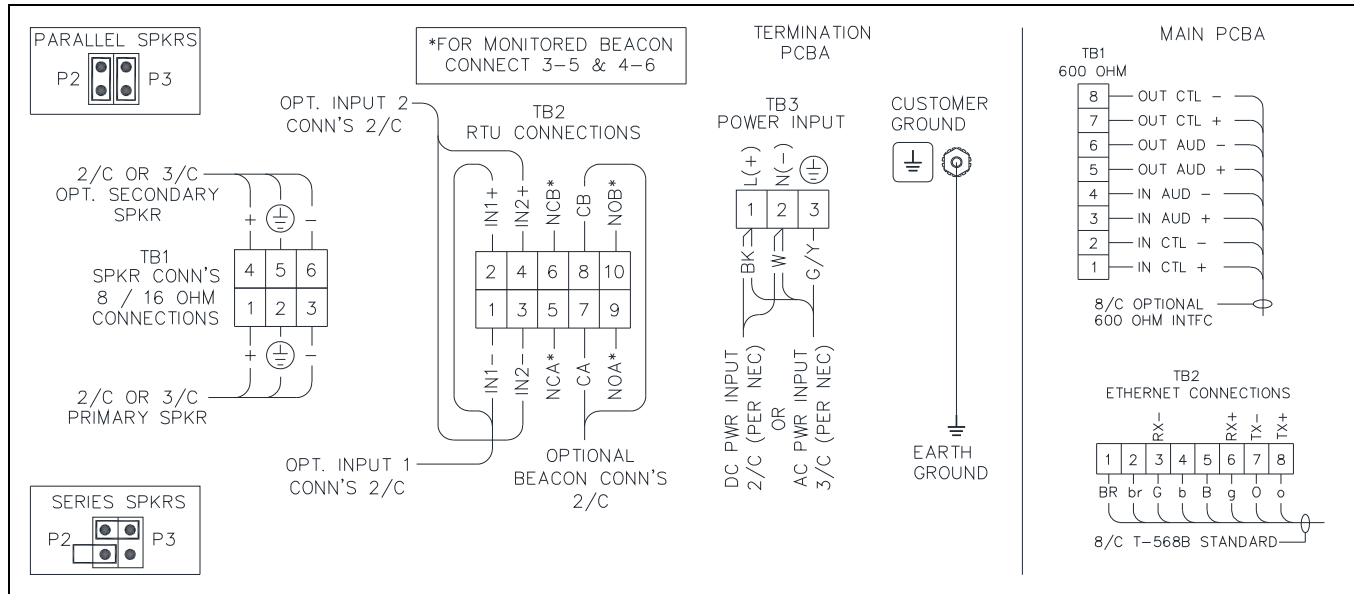

Figure 3. SP2 Connection Diagrams

Front Panel Installation

After all terminations and adjustments are complete:

1. Place the front cover on the rear enclosure.
Do not to pinch any cables.
2. Secure the front cover using the four screws and washers provided.
3. Torque the screws to 10–12 in·lb (1.13–1.36 N·m).

Programming

SP2 stations are factory configured to provide basic page/party functions upon power-up. Configure stations for custom operation and/or larger system designs using the CLI or SP2 Console application. Refer to Publication 42004-786, SP2 Weatherproof Handset/Speaker Amplifier Station (see the [Reference Documentation](#) section).

Reference Documentation

SP2 Weatherproof Handset/Speaker Amplifier Station.....	42004-786
SP2 Configuration Guide.....	42004-784

Approvals

NRTL certified for use in US and Canada.....UL/CSA 60950
CE Mark

Warranty

Equipment. GAI-Tronics warrants for a period of one (1) year from the date of shipment, that any GAI-Tronics equipment supplied hereunder shall be free of defects in material and workmanship, shall comply with the then-current product specifications and product literature, and if applicable, shall be fit for the purpose specified in the agreed-upon quotation or proposal document. If (a) Seller's goods prove to be defective in workmanship and/or material under normal and proper usage, or unfit for the purpose specified and agreed upon, and (b) Buyer's claim is made within the warranty period set forth above, Buyer may return such goods to GAI-Tronics' nearest depot repair facility, freight prepaid, at which time they will be repaired or replaced, at Seller's option, without charge to Buyer. Repair or replacement shall be Buyer's sole and exclusive remedy. The warranty period on any repaired or replacement equipment shall be the greater of the ninety (90) day repair warranty or one (1) year from the date the original equipment was shipped. In no event shall GAI-Tronics warranty obligations with respect to equipment exceed 100% of the total cost of the equipment supplied hereunder. Buyer may also be entitled to the manufacturer's warranty on any third-party goods supplied by GAI-Tronics hereunder. The applicability of any such third-party warranty will be determined by GAI-Tronics.

Services. Any services GAI-Tronics provides hereunder, whether directly or through subcontractors, shall be performed in accordance with the standard of care with which such services are normally provided in the industry. If the services fail to meet the applicable industry standard, GAI-Tronics will re-perform such services at no cost to buyer to correct said deficiency to Company's satisfaction provided any and all issues are identified prior to the demobilization of the Contractor's personnel from the work site. Re-performance of services shall be Buyer's sole and exclusive remedy, and in no event shall GAI-Tronics warranty obligations with respect to services exceed 100% of the total cost of the services provided hereunder.

Warranty Periods. Every claim by Buyer alleging a defect in the goods and/or services provided hereunder shall be deemed waived unless such claim is made in writing within the applicable warranty periods as set forth above. Provided, however, that if the defect complained of is latent and not discoverable within the above warranty periods, every claim arising on account of such latent defect shall be deemed waived unless it is made in writing within a reasonable time after such latent defect is or should have been discovered by Buyer.

Limitations / Exclusions. The warranties herein shall not apply to, and GAI-Tronics shall not be responsible for, any damage to the goods or failure of the services supplied hereunder, to the extent caused by Buyer's neglect, failure to follow operational and maintenance procedures provided with the equipment, or the use of technicians not specifically authorized by GAI-Tronics to maintain or service the equipment. **THE WARRANTIES AND REMEDIES CONTAINED HEREIN ARE IN LIEU OF AND EXCLUDE ALL OTHER WARRANTIES AND REMEDIES, WHETHER EXPRESS OR IMPLIED BY OPERATION OF LAW OR OTHERWISE, INCLUDING ANY WARRANTIES OF MERCHANTABILITY OR FITNESS FOR A PARTICULAR PURPOSE.**

Return Policy

If the equipment requires service, contact your Regional Service Center for a return authorization number (RA#). Equipment should be shipped prepaid to GAI-Tronics with a return authorization number and a purchase order number. If the equipment is under warranty, repairs or a replacement will be made in accordance with the warranty policy set forth above. Please include a written explanation of all defects to assist our technicians in their troubleshooting efforts.

Call 800-492-1212 (inside the USA) or 610-777-1374 (outside the USA) for help identifying the Regional Service Center closest to you.